



# MS2/MS3 SERIES (IE2/IE3)

## THREE PHASE ALUMINIUM HOUSING MOTOR

Three phase, MS2/MS3(IE2/IE3) series aluminium housing motors are acknowledged that having a good fame for quality and reliability, they are suitable for driving machines which do not have special requirement, such as machine tools, pumps, blowers, etc.

- Superior finish - Externally Ventilated - Light weight construction
- Top mounted terminal box - IP55 Protection
- Interchangeable foot mounting and flange mounting

### Operating Conditions:

Ambient temperature: -15°C ~ ≤40°C

Altitude: not exceed 1000m

Rated voltage: ±5%

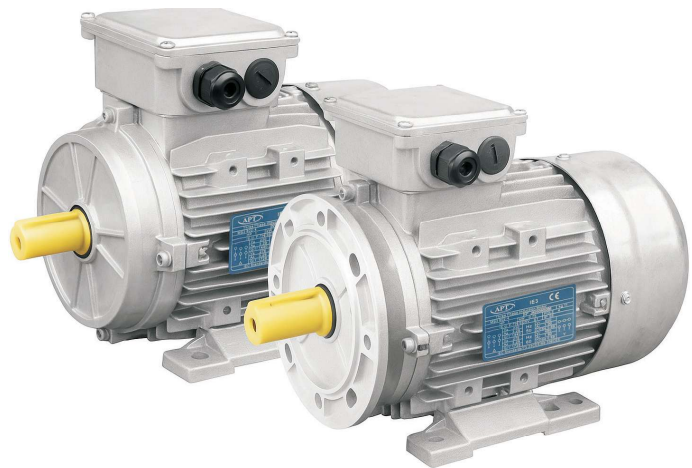

### MS2 Series IE2 Efficiency Motors Technical Data (at 50HZ) - 2 pol

Model	Power (kW)	Current(A)			Current(A)			Current(A)			Speed (r/min)	Eff. (%)	Power Factor (cos φ)	Tst/Tn (Times)	Tmax/Tn (Times)	Tmin/Tn (Times)	Ist/In (Times)	Noise dB(A)	W.T (kg)	Inertia kg*m²
		220V	380V	660V	230V	400V	690V	240V	415V	720V										
MS2 562-2	0.12	0.75	0.44	0.25	0.72	0.41	0.24	0.69	0.4	0.23	2700	53.6	0.78	2.2	5.2	2.1		57	3.4	0.000023
MS2-631-2	0.18	0.98	0.57	0.33	0.94	0.54	0.31	0.9	0.52	0.3	2720	60.4	0.80	2.3	5.5	2.3		61	3.8	0.000031
MS2-632-2	0.25	1.25	0.72	0.42	1.29	0.69	0.4	1.25	0.66	0.38	2720	64.8	0.81	2.3	5.5	2.3		61	4	0.000060
MS2-711-2	0.37	1.72	1	0.57	1.65	0.96	0.55	1.58	0.91	0.53	2755	69.5	0.81	2.2	6.1	2.3		64	6.5	0.000075
MS2-712-2	0.55	2.37	1.4	0.79	2.27	1.3	0.76	2.18	1.26	0.73	2790	74.1	0.82	2.3	6.1	2.3		64	6.7	0.000090
MS2 713-2	0.75	3.23	1.86	1.08	3.07	1.77	1.02	2.96	1.71	0.99	2810	77.4	0.79	3.4	3.5	3	5.8	65	7.5	0.000480
MS2 801-2	0.75	3.15	1.82	1.05	2.99	1.73	1.00	2.88	1.66	0.96	2840	77.4	0.81	3.3	3.5	2.7	6.9	67	8.9	0.000852
MS2 802-2	1.1	4.43	2.56	1.48	4.21	2.43	1.40	4.06	2.34	1.35	2860	79.6	0.82	3.5	3.7	2.8	7.2	67	10.6	0.001109
MS2 803-2	1.5	5.99	3.46	2.00	5.69	3.29	1.90	5.49	3.17	1.83	2860	81.3	0.81	3.7	3.8	2.9	7.7	70	13	0.001430
MS2 90S-2	1.5	5.85	3.38	1.95	5.56	3.21	1.85	5.36	3.09	1.79	2860	81.3	0.83	4.5	3.5	2.7	8.2	72	13.2	0.001430
MS2 90L1-2	2.2	8.38	4.84	2.79	7.96	4.60	2.66	7.68	4.43	2.56	2870	83.2	0.83	4.5	4.1	2.7	7.4	72	16.1	0.002181
MS2 90L2-2	3	11.2	6.49	3.75	10.7	6.17	3.56	10.29	5.94	3.43	2880	84.6	0.83	4.5	4.1	3	9.7	74	20	0.002904
MS2 100L1-2	3	10.9	6.26	3.62	10.3	5.95	3.44	9.94	5.74	3.31	2900	84.6	0.86	3.7	3.7	2.6	9.6	76	22.7	0.003008
MS2 100L2-2	4	13.9	8.05	4.65	13.2	7.65	4.42	12.8	7.37	4.26	2890	85.8	0.88	3.6	3.4	2.6	9.5	77	26	0.003934
MS2 112M-2	4	14.1	8.14	4.70	13.4	7.73	4.47	12.9	7.46	4.30	2910	85.8	0.87	3.4	3.8	2.2	9.7	77	26.4	0.006266
MS2 112L-2	5.5	18.9	10.9	6.30	18.0	10.4	5.99	17.3	9.99	5.77	2920	87	0.88	4	4.3	3	11	78	32.1	0.007819
MS2 132S1-2	5.5	18.9	10.9	6.30	18.0	10.4	5.99	17.3	9.99	5.77	2920	87	0.88	3.9	4	2.1	9.9	80	42.3	0.012022
MS2 132S2-2	7.5	25.2	14.5	8.39	23.9	13.8	7.97	23.0	13.3	7.68	2910	88.1	0.89	3.5	3.7	1.9	9.5	80	46.2	0.014635
MS2 132M1-2	9.2	31.0	17.9	10.3	29.5	17.0	9.82	28.4	16.4	9.47	2900	88.7	0.88	3.5	3.9	2.4	9.8	81	51.6	0.016303
MS2 132M2-2	11	37.7	21.7	12.6	35.8	20.7	11.9	34.5	19.9	11.5	2930	89.4	0.86	3.5	3.9	2.4	11.5	83	54.5	0.019439
MS2 160M1-2	11	36.4	21.0	12.1	34.6	20.0	11.5	33.3	19.2	11.1	2940	89.4	0.89	3.2	3.2	2.2	9	86	79.2	0.048471
MS2 160M2-2	15	48.6	28.0	16.2	46.1	26.6	15.4	44.5	25.7	14.8	2930	90.3	0.9	3.2	3.2	2.2	9	86	96.6	0.059421
MS2 160L-2	18.5	58.9	34.0	19.6	55.9	32.3	18.6	53.9	31.1	18.0	2930	90.9	0.91	3.2	3.2	2.2	9	86	102.5	0.068807
MS2 180M-2	22	69.7	40.2	23.2	66.2	38.2	22.1	63.8	36.8	21.3	2950	91.3	0.91	2.5	2	1.4	8.1	91	128	0.095016
MS2 200L1-2	30	94.3	54.4	31.4	89.6	51.7	29.9	86.3	49.9	28.8	2950	92	0.91	2.5	3.3	1.3	8.8	94	158	0.122246
MS2 200L2-2	37	115.7	66.8	38.6	109.9	63.4	36.6	105.9	61.2	35.3	2960	92.5	0.91	2.8	3.5	1.3	9.6	94	181.3	0.148816

**MS2 Series IE2 Efficiency Motors Technical Data (at 50HZ) - 4 pol**

Model	Power (kW)	Current(A)			Current(A)			Current(A)			Speed (r/min)	Eff. (%)	Power Factor (cos φ)	Tst/Tn (Times)	Tmax/Tn (Times)	Tmin/Tn (Times)	Ist/In (Times)	Noise dB(A)	W.T (kg)	Inertia kg*m <sup>2</sup>
		220V	380V	660V	230V	400V	690V	240V	415V	720V										
MS2-631-4	0.12	0.74	0.43	0.25	0.71	0.41	0.23	0.68	0.39	0.23	1310	59.1	0.72	2.2	4.4	2.1		52	4.1	0.000050
MS2-632-4	0.18	1	0.58	0.33	0.96	0.55	0.32	0.92	0.53	0.31	1310	64.7	0.73	2.2	4.4	2.1		52	4.6	0.000060
MS2-633-4	0.25	1.29	0.75	0.43	1.24	0.71	0.41	1.18	0.69	0.39	1340	68.5	0.74	2.2	5.2	2.1		55	5.6	0.000080
MS2-711-4	0.25	1.29	0.75	0.43	1.24	0.71	0.41	1.18	0.69	0.39	1340	68.5	0.74	2.2	5.2	2.1		55	6.3	0.000080
MS2-712-4	0.37	1.78	1.03	0.59	1.7	0.98	0.57	1.63	0.94	0.54	1340	72.7	0.75	2.2	5.2	2.1		55	6.8	0.000130
MS2-713-4	0.55	2.49	1.4	0.83	2.39	1.4	0.8	2.29	1.32	0.76	1390	77.1	0.75	2.3	5.2	2.4		58	8.5	0.000180
MS2-801-4	0.55	2.49	1.4	0.83	2.39	1.4	0.8	2.29	1.32	0.76	1390	77.1	0.75	2.3	5.2	2.4		58	11.5	0.000180
MS2 802-4	0.75	3.31	1.91	1.10	3.14	1.81	1.05	3.03	1.75	1.01	1410	79.6	0.75	3	2.9	2.4	5.8	58	11.1	0.002060
MS2 90S-4	1.1	5.01	2.89	1.67	4.76	2.75	1.59	4.59	2.65	1.53	1420	81.4	0.71	2.8	3.1	2.6	5.6	61	13.9	0.002873
MS2 90L-4	1.5	6.71	3.88	2.24	6.38	3.68	2.13	6.15	3.55	2.05	1420	82.8	0.71	3	3.1	2.7	6.2	61	16.9	0.003709
MS2 100L1-4	2.2	8.92	5.15	2.97	8.47	4.89	2.82	8.17	4.72	2.72	1440	84.3	0.77	3.3	3.6	2.9	7.6	64	22.4	0.007306
MS2 100L2-4	3	11.8	6.83	3.95	11.2	6.49	3.75	10.8	6.26	3.61	1440	85.5	0.78	3.4	3.6	3	7.4	64	26.4	0.009053
MS2 112M-4	4	15.0	8.66	5.00	14.3	8.23	4.75	13.7	7.93	4.58	1440	86.6	0.81	2.9	3.1	2.3	8.2	65	32.3	0.013305
MS2 132S-4	5.5	20.1	11.6	6.71	19.1	11.0	6.37	18.4	10.6	6.14	1450	87.7	0.82	2.6	3.4	2.2	8.7	71	43	0.027736
MS2 132M-4	7.5	26.5	15.3	8.83	25.2	14.5	8.39	24.3	14.0	8.09	1450	88.7	0.84	3.1	3.4	2.1	8.8	71	52.6	0.035864
MS2 132L-4	9.2	31.9	18.4	10.6	30.3	17.5	10.1	29.2	16.9	9.75	1450	89.2	0.85	2.9	3.2	2	8.8	74	59	0.041954
MS2 160M-4	11	38.4	22.2	12.8	36.5	21.0	12.2	35.1	20.3	11.7	1460	89.8	0.84	2.5	2.9	1.6	7.3	75	83	0.089630
MS2 160L1-4	15	51.9	29.9	17.3	49.3	28.4	16.4	47.5	27.4	15.8	1460	90.6	0.84	2.9	3	1.7	8.2	75	103.5	0.118354
MS2 160L2-4	18.5	62.8	36.3	20.9	59.7	34.4	19.9	57.5	33.2	19.2	1460	91.2	0.85	2.9	3	1.7	8.1	78	114.5	0.136633
MS2 180M-4	18.5	61.4	35.4	20.5	58.3	33.7	19.4	56.2	32.4	18.7	1460	91.2	0.87	2.4	3	1.8	7.8	80	119	0.155064
MS2 180L-4	22	71.8	41.5	23.9	68.2	39.4	22.7	65.8	38.0	21.9	1460	91.6	0.88	2.4	2.8	1.7	7.7	80	129	0.173293
MS2 200L-4	30	99.5	57.4	33.2	94.5	54.6	31.5	91.1	52.6	30.4	1470	92.3	0.86	3.2	3.7	2.3	9.5	83	169.2	0.242313

**MS2 Series IE2 Efficiency Motors Technical Data (at 50HZ) - 6 pol**

Model	Power (kW)	Current(A)			Current(A)			Current(A)			Speed (r/min)	Eff. (%)	Power Factor (cos φ)	Tst/Tn (Times)	Tmax/Tn (Times)	Tmin/Tn (Times)	Ist/In (Times)	Noise dB(A)	W.T (kg)	Inertia kg*m <sup>2</sup>
		220V	380V	660V	230V	400V	690V	240V	415V	720V										
MS2-711-6	0.18	1.26	0.73	0.42	1.21	0.7	0.4	1.16	0.67	0.39	870	56.6	0.66	2	4	1.9		52	6.2	0.001100
MS2-712-6	0.25	1.57	0.91	0.52	1.5	0.86	0.5	1.44	0.83	0.48	870	61.6	0.68	2	4	1.9		52	6.5	0.001400
MS2-801-6	0.37	2.05	1.2	0.68	1.96	1.1	0.65	1.88	1.1	0.63	880	67.6	0.7	2	4.7	1.9		54	12	0.001600
MS2-802-6	0.55	2.74	1.6	0.91	2.62	1.5	0.87	2.51	1.45	0.84	880	73.1	0.72	2.1	4.7	1.9		54	12.5	0.001900
MS2 90S-6	0.75	3.77	2.18	1.26	3.58	2.07	1.19	3.45	1.99	1.15	935	75.9	0.69	2.4	2.6	2.2	4.7	59	13	0.003365
MS2 90L-6	1.1	5.37	3.10	1.79	5.10	2.95	1.70	4.92	2.84	1.64	940	78.1	0.69	2.7	2.7	2.3	5	59	16.4	0.004805
MS2 100L-6	1.5	6.87	3.97	2.29	6.53	3.77	2.18	6.29	3.63	2.10	960	79.8	0.72	2.9	3	2.3	6.2	61	21.6	0.009554
MS2 112M-6	2.2	9.44	5.45	3.15	8.96	5.18	2.99	8.64	4.99	2.88	950	81.8	0.75	2.5	2.6	2	5.6	64	29.5	0.016969
MS2 132S-6	3	12.5	7.20	4.16	11.8	6.84	3.95	11.4	6.59	3.81	960	83.3	0.76	2.2	2.6	1.7	6.1	64	35.2	0.029932
MS2 132M1-6	4	16.6	9.58	5.53	15.8	9.10	5.25	15.2	8.77	5.06	965	84.6	0.75	2.5	2.6	1.7	6.5	68	45	0.040259
MS2 132M2-6	5.5	22.7	13.1	7.58	21.6	12.5	7.20	20.8	12.0	6.94	965	86	0.74	3	2.9	1.9	7.2	68	53.5	0.053408
MS2 132L-6	7.5	30.2	17.4	10.1	28.7	16.6	9.56	27.6	16.0	9.21	970	87.2	0.75	3.7	3.1	2.2	8.2	68	66.2	0.068087
MS2 160M-6	7.5	30.6	17.7	10.2	29.1	16.8	9.69	28.0	16.2	9.34	970	87.2	0.74	2.8	2.9	1.6	7.1	68	72.6	0.089688
MS2 160L-6	11	42.9	24.8	14.3	40.8	23.6	13.6	39.3	22.7	13.1	970	88.7	0.76	2.9	2.7	1.6	7.3	73	89.5	0.122730
MS2 180L-6	15	53.0	30.6	17.7	50.4	29.1	16.8	48.5	28.0	16.2	975	89.7	0.83	2.2	2.7	1.2	8	79	130	0.254063
MS2 200L1-6	18.5	64.9	37.5	21.6	61.6	35.6	20.5	59.4	34.3	19.8	975	90.4	0.83	2.1	2.9	1.5	8.3	82	149	0.303941
MS2 200L2-6	22	76.7	44.3	25.6	72.9	42.1	24.3	70.3	40.6	23.4	975	90.9	0.83	2.2	3	1.6	8.9	82	167	0.353160

**MS3 Series IE3 Efficiency Motors Technical Data (at 50HZ) - 2 pol**

Model	Power (kW)	Current(A)			Current(A)			Current(A)			Speed (r/min)	Eff.			Power Factor	Tstart/Tn (Times)	Tmax/Tn (Times)	Tmin/Tn (Times)	Is/In (Times)	Noise dB(A)	W.T (kg)	Inertia kg*m <sup>2</sup>
		220V	380V	660V	230V	400V	690V	240V	415V	720V		100%	75%	50%								
MS3 631-2	0.18	0.96	0.55	0.32	0.91	0.53	0.30	0.88	0.51	0.29	2850	65.9	63.5	56.2	0.75	2	2.5	1.6	4.7	61	3.6	0.000231
MS3 632-2	0.25	1.21	0.70	0.40	1.15	0.66	0.38	1.11	0.64	0.37	2840	69.7	68.4	62.5	0.78	2.5	2.7	2	5.2	61	3.9	0.000255
MS3 711-2	0.37	1.74	1.00	0.58	1.65	0.95	0.55	1.59	0.92	0.53	2860	73.8	72.4	66.5	0.76	2.5	2.8	1.8	5.6	64	5.2	0.000369
MS3 712-2	0.55	2.33	1.34	0.78	2.21	1.28	0.74	2.13	1.23	0.71	2860	77.8	63.5	56.2	0.80	3.1	3.1	2	6.5	64	6.2	0.000495

MS3 Series IE3 Efficiency Motors Technical Data (at 50HZ) - 2 pol

Model	Power (kW)	Current(A)			Current(A)			Current(A)			Speed (r/min)	Eff.			Power Factor	Tstart/Tn (Times)	Tmax/Tn (Times)	Tmin/Tn (Times)	Is/In (Times)	Noise dB(A)	W.T (kg)	Inertia kg*m <sup>2</sup>
		220V	380V	660V	230V	400V	690V	240V	415V	720V		100%	75%	50%								
MS3 713-2	0.75	2.98	1.72	0.99	2.83	1.64	0.94	2.73	1.58	0.91	2870	80.7	80.8	78.2	0.82	3	3.2	2.2	7.1	65	7.1	0.000606
MS3 801-2	0.75	3.02	1.74	1.01	2.87	1.66	0.96	2.76	1.60	0.92	2890	80.7	80.3	77.2	0.81	3.1	3.2	2.3	7.4	67	8.9	0.000972
MS3 802-2	1.1	4.22	2.43	1.41	4.01	2.31	1.34	3.86	2.23	1.29	2890	82.7	82.5	79.9	0.83	3.4	3.4	2	8.7	67	10.6	0.001275
MS3 803-2	1.5	5.79	3.34	1.93	5.50	3.17	1.83	5.30	3.06	1.77	2910	84.2	83.9	81.5	0.81	4	4	2.2	9.6	70	12.5	0.001654
MS3 905-2	1.5	5.72	3.30	1.91	5.43	3.14	1.81	5.24	3.02	1.75	2900	84.2	83.8	81.4	0.82	3.5	3.7	2.1	8.3	72	14	0.002186
MS3 90L1-2	2.2	8.22	4.75	2.74	7.81	4.51	2.60	7.53	4.35	2.51	2910	85.9	86.1	84.7	0.82	3.1	3.5	2.2	8.1	72	16.3	0.002636
MS3 90L2-2	3	11.3	6.54	3.78	10.8	6.21	3.59	10.37	5.99	3.46	2910	87.1	87.1	84.2	0.80	4	4.1	2.6	9.6	74	18.5	0.003406
MS3 100L1-2	3	10.2	5.88	3.39	9.7	5.59	3.23	9.33	5.38	3.11	2910	87.1	87.5	86.3	0.89	3.2	3.6	2.6	9.4	76	23.7	0.004842
MS3 100L2-2	4	13.3	7.66	4.43	12.6	7.28	4.20	12.2	7.02	4.05	2910	88.1	88.7	88.1	0.90	3.3	3.6	2.3	10.1	77	27.6	0.005907
MS3 112M1-2	4	13.1	7.58	4.38	12.5	7.20	4.16	12.0	6.94	4.01	2920	88.1	88.2	87.0	0.91	3.4	3.9	2.4	10.5	77	30.1	0.007505
MS3 112M2-2	5.5	17.8	10.3	5.94	16.9	9.78	5.65	16.3	9.43	5.44	2920	89.2	89.6	89.1	0.91	3.3	4.2	2.9	11.9	78	35.7	0.009251
MS3 132S1-2	5.5	18.2	10.5	6.08	17.3	10.0	5.77	16.7	9.64	5.56	2930	89.2	89.4	88.2	0.89	3.2	4	2.5	10	80	43.4	0.015212
MS3 132S2-2	7.5	24.3	14.1	8.11	23.1	13.4	7.71	22.3	12.9	7.43	2930	90.1	90.2	89.1	0.90	3.6	4.7	2.4	11.9	80	51.7	0.018996
MS3 132M1-2	9.2	29.4	17.0	9.79	27.9	16.1	9.30	26.9	15.5	8.96	2930	90.6	91.2	90.5	0.91	3.2	4.2	2.6	11.6	81	58.3	0.021619
MS3 132M2-2	11	34.5	19.9	11.5	32.8	18.9	10.9	31.6	18.2	10.5	2930	91.2	91.5	91.2	0.92	3.6	4.1	2.4	12.2	83	63.5	0.024142
MS3 132M3-2	15	47.7	27.6	15.9	45.3	26.2	15.1	43.7	25.2	14.6	2940	91.9	92.1	91.2	0.90	4.9	4.9	2	14.4	86	75	0.028557
MS3 160M1-2	11	36.1	20.8	12.0	34.3	19.8	11.4	33.0	19.1	11.0	2960	91.2	91	89.6	0.88	3.2	4	1.4	10.3	86	85.5	0.059613
MS3 160M2-2	15	48.3	27.9	16.1	45.8	26.5	15.3	44.2	25.5	14.7	2960	91.9	91.5	89.9	0.89	3.9	4.2	1.4	11.4	86	104	0.076751
MS3 160L1-2	18.5	57.9	33.4	19.3	55.0	31.8	18.3	53.0	30.6	17.7	2950	92.4	92.8	91.8	0.91	3	3	1.5	9.1	86	121	0.092252
MS3 180M-2	22	68.6	39.6	22.9	65.2	37.6	21.7	62.8	36.3	20.9	2960	92.7	93	92.4	0.91	2.7	3.3	1.7	9	91	130.6	0.104677
MS3 200L1-2	30	94.0	54.3	31.3	89.3	51.6	29.8	86.1	49.7	28.7	2960	93.3	93.2	92.2	0.90	3.5	3.8	1.8	10.2	94	158	0.136738
MS3 200L2-2	37	115.5	66.7	38.5	109.7	63.3	36.6	105.7	61.0	35.2	2960	93.7	93.6	92.6	0.90	3.6	3.7	1.7	9.8	94	173.1	0.163308

MS3 Series IE3 Efficiency Motors Technical Data (at 50HZ) - 4 pol

Model	Power (kW)	Current(A)			Current(A)			Current(A)			Speed (r/min)	Eff.			Power Factor	Tstart/Tn (Times)	Tmax/Tn (Times)	Tmin/Tn (Times)	Is/In (Times)	Noise dB(A)	W.T (kg)	Inertia kg*m <sup>2</sup>
		220V	380V	660V	230V	400V	690V	240V	415V	720V		100%	75%	50%								
MS3 631-4	0.12	0.70	0.40	0.23	0.66	0.38	0.22	0.64	0.37	0.21	1360	64.8	63.7	57.6	0.70	2.2	2.3	2	3.5	52	3.8	0.000305
MS3 632-4	0.18	0.97	0.56	0.32	0.92	0.53	0.31	0.89	0.51	0.30	1400	69.9	69.6	65.4	0.70	2.2	2.5	2.1	4.1	52	4.5	0.000399
MS3 711-4	0.25	1.30	0.75	0.43	1.23	0.71	0.41	1.19	0.69	0.40	1410	73.5	73.2	69.0	0.69	2.3	2.5	2.1	4.5	55	5.8	0.000717
MS3 712-4	0.37	1.85	1.07	0.62	1.76	1.02	0.59	1.70	0.98	0.57	1420	77.3	77.1	73.6	0.68	2.8	3	2.5	5.2	55	7	0.000965
MS3 801-4	0.55	2.80	1.62	0.93	2.66	1.54	0.89	2.56	1.48	0.85	1440	80.8	79.9	76.0	0.64	3.1	3.3	2.4	6.2	57	9.5	0.001690
MS3 802-4	0.75	3.47	2.00	1.16	3.29	1.90	1.10	3.17	1.83	1.06	1440	82.5	82.5	80.1	0.69	3.1	3.1	2.5	6.3	58	11.7	0.002285
MS3 803-4	1.1	4.65	2.69	1.55	4.42	2.55	1.47	4.26	2.46	1.42	1430	84.1	84.9	83.7	0.74	3	3.1	2.6	6.6	61	13.8	0.002998
MS3 905-4	1.1	4.72	2.72	1.57	4.48	2.59	1.49	4.32	2.49	1.44	1440	84.1	84.2	82.9	0.73	4	3.4	2.5	7.1	61	15.1	0.003842
MS3 90L1-4	1.5	6.25	3.61	2.08	5.94	3.43	1.98	5.73	3.31	1.91	1430	85.3	85.5	84.1	0.74	3.4	3.3	2.8	7.1	61	18	0.004685
MS3 100L1-4	2.2	8.35	4.82	2.78	7.93	4.58	2.64	7.64	4.41	2.55	1450	86.7	87.1	86.2	0.80	2.8	3.3	2.3	7.9	64	23.9	0.008754
MS3 100L2-4	3	11.5	6.66	3.85	11.0	6.33	3.65	10.6	6.10	3.52	1450	87.7	88	86.9	0.78	3.3	3.4	2.7	8.1	64	28.3	0.011063
MS3 112M1-4	4	14.5	8.37	4.83	13.8	7.95	4.59	13.3	7.66	4.42	1450	88.6	88.8	88.2	0.82	3.1	3.7	2.6	8.6	65	33.9	0.015292
MS3 112M2-4	5.5	20.2	11.7	6.73	19.2	11.1	6.39	18.5	10.7	6.16	1450	89.6	89.9	89.1	0.80	3.8	3.7	2.5	9.1	71	39.1	0.048758

MS3 Series IE3 Efficiency Motors Technical Data (at 50HZ) - 4 pol

Model	Power (kW)	Current(A)			Current(A)			Current(A)			Speed (r/min)	Eff.			Power Factor	Tstart/Tn (Times)	Tmax/Tn (Times)	Tmin/Tn (Times)	Is/In (Times)	Noise dB(A)	W.T (kg)	Inertia kg*m <sup>2</sup>
		220V	380V	660V	230V	400V	690V	240V	415V	720V		100%	75%	50%								
MS3 132S-4	5.5	19.2	11.1	6.41	18.3	10.5	6.09	17.6	10.2	5.87	1460	89.6	89.8	89.4	0.84	2.3	3.5	1.9	9	71	47.4	0.034464
MS3 132M1-4	7.5	26.0	15.0	8.66	24.7	14.3	8.23	23.8	13.7	7.93	1460	90.4	90.9	90.3	0.84	2.6	3.4	2.2	8.9	71	57.4	0.043597
MS3 132M2-4	9.2	32.5	18.8	10.8	30.9	17.8	10.3	29.8	17.2	9.93	1460	90.8	91.3	90.7	0.82	3.2	3.6	2	10	74	60	0.051339
MS3 132M3-4	11	37.7	21.8	12.6	35.8	20.7	11.9	34.5	19.9	11.5	1460	91.4	92	91.6	0.84	3.5	3.7	2.1	10.5	75	67	0.060372
MS3 160M-4	11	38.2	22.0	12.7	36.3	20.9	12.1	34.9	20.2	11.6	1470	91.4	91.7	89.8	0.83	2.6	2.8	1.8	7.6	75	89	0.105373
MS3 160L1-4	15	50.4	29.1	16.8	47.9	27.7	16.0	46.2	26.7	15.4	1470	92.1	92.3	91.3	0.85	3	3	2	9.2	75	110.5	0.137038
MS3 180M-4	18.5	61.1	35.3	20.4	58.1	33.5	19.4	56.0	32.3	18.7	1470	92.6	92.8	92.1	0.86	2.8	3.3	1.9	8.8	80	130	0.173293
MS3 180L-4	22	72.4	41.8	24.1	68.8	39.7	22.9	66.3	38.3	22.1	1470	93	93.1	92.3	0.86	3	3.5	2.1	9.3	80	145.4	0.200637
MS3 200L-4	30	95.8	55.3	32.0	91.1	52.6	30.4	87.8	50.7	29.3	1470	93.6	93.7	92.9	0.88	3.2	3.7	2.1	9.7	83	180	0.265100

MS3 Series IE3 Efficiency Motors Technical Data (at 50HZ) - 6 pol

Model	Power (kW)	Current(A)			Current(A)			Current(A)			Speed (r/min)	Eff.			Power Factor	Tstart/Tn (Times)	Tmax/Tn (Times)	Tmin/Tn (Times)	Is/In (Times)	Noise dB(A)	W.T (kg)	Inertia kg*m <sup>2</sup>
		220V	380V	660V	230V	400V	690V	240V	415V	720V		100%	75%	50%								
MS3 711-6	0.18	1.20	0.69	0.40	1.14	0.66	0.38	1.09	0.63	0.36	930	63.9	61	53.4	0.62	2.4	2.6	2.3	3.5	52	5.4	0.000790
MS3 712-6	0.25	1.48	0.85	0.49	1.40	0.81	0.47	1.35	0.78	0.45	920	68.6	67.2	61.2	0.65	2.2	2.5	2.2	3.7	52	6.3	0.001020
MS3 801-6	0.37	1.95	1.12	0.65	1.85	1.07	0.62	1.78	1.03	0.59	930	73.5	73.8	70.5	0.68	2.2	2.5	2.1	4.1	56	9.3	0.002189
MS3 802-6	0.55	2.64	1.52	0.88	2.51	1.45	0.84	2.42	1.40	0.81	930	77.2	78.1	75.7	0.71	2.3	2.4	2.1	4.3	56	10.9	0.002931
MS3 90S-6	0.75	3.73	2.16	1.24	3.55	2.05	1.18	3.42	1.97	1.14	950	78.9	80.1	78.1	0.67	2.3	2.6	2.1	4.7	59	13.8	0.004070
MS3 90L-6	1.1	5.33	3.08	1.78	5.07	2.93	1.69	4.88	2.82	1.63	950	81	81.1	78.4	0.67	2.7	2.9	2.5	5.2	59	16.2	0.005487
MS3 90L2-6	1.5	7.14	4.12	2.38	6.78	3.92	2.26	6.54	3.78	2.18	950	82.5	82.7	80.5	0.67	2.9	3	2.6	5.6	61	21.3	0.006895
MS3 100L-6	1.5	6.84	3.95	2.28	6.49	3.75	2.16	6.26	3.61	2.09	955	82.5	83	81.8	0.70	2.4	2.9	2.2	5.5	61	22.1	0.009137
MS3 100L2-6	2.2	9.54	5.51	3.18	9.06	5.23	3.02	8.73	5.04	2.91	955	84.3	85.1	83.9	0.72	2.5	3	2.3	6.2	64	27.7	0.012725
MS3 112M-6	2.2	10.1	5.83	3.37	9.59	5.54	3.20	9.25	5.34	3.08	965	84.3	84.5	83.2	0.68	2	2.5	1.8	5.5	64	27.1	0.017675
MS3 112M2-6	3	13.4	7.72	4.46	12.7	7.33	4.23	12.2	7.07	4.08	965	85.6	86.2	84.8	0.69	2.5	2.9	1.9	6.3	64	33.1	0.021400
MS3 132S-6	3	12.5	7.20	4.15	11.8	6.84	3.95	11.4	6.59	3.80	965	85.6	86	85.1	0.74	2	2.7	1.7	6	64	38.6	0.033804
MS3 132M1-6	4	16.4	9.46	5.46	15.6	8.99	5.19	15.0	8.66	5.00	970	86.8	87.1	86.2	0.74	2.3	3	1.8	6.8	68	47.6	0.043946
MS3 132M2-6	5.5	23.2	13.4	7.72	22.0	12.7	7.34	21.2	12.2	7.07	975	88	88.3	87.1	0.71	2.9	3.5	2.2	7.4	68	55.7	0.053987
MS3 132M3-6	7.5	30.8	17.8	10.3	29.2	16.9	9.74	28.2	16.3	9.39	970	89.1	89.6	88.6	0.72	3.3	3.2	2	8.3	68	67.6	0.070723
MS3 160M-6	7.5	29.1	16.8	9.72	27.7	16.0	9.23	26.7	15.4	8.90	975	89.1	89.5	88.5	0.76	2.2	2.9	1.8	7.3	68	79.6	0.109012
MS3 160L-6	11	41.1	23.7	13.7	39.0	22.5	13.0	37.6	21.7	12.5	975	90.3	90.8	89.9	0.78	2.7	2.9	1.2	8.4	73	105	0.154850
MS3 180L-6	15	52.1	30.1	17.4	49.5	28.6	16.5	47.7	27.6	15.9	960	91.2	90.9	89.4	0.83	2.3	2.9	2.1	7.8	79	125.2	0.275157
MS3 200L1-6	18.5	66.4	38.3	22.1	63.0	36.4	21.0	60.8	35.1	20.3	980	91.7	91.5	90.1	0.80	2.7	3.7	2.2	9.8	82	143	0.332066
MS3 200L2-6	22	78.5	45.3	26.2	74.6	43.1	24.9	71.9	41.5	24.0	980	92.2	92	90.6	0.80	2.9	3.7	2.3	10.5	82	162	0.388316

### Motor Spare Part List "Exploded Drawing"

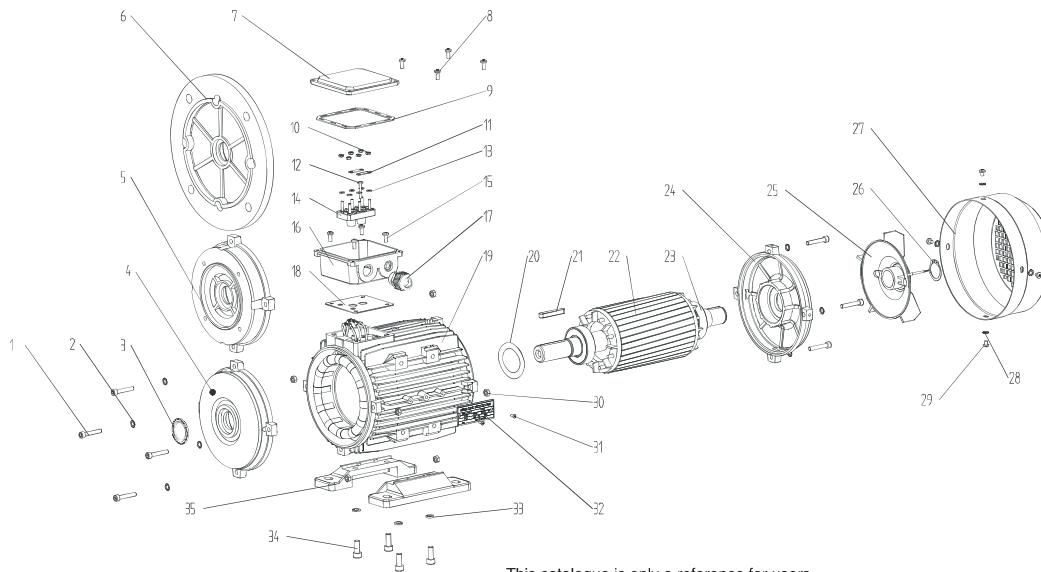

1. Endshield fixing screws
2. Gasket
3. Oil seal
4. Front endshield
5. B14 flange
6. B5 flange
7. TB cover
8. TB fixing screws
9. TB upper gasket
10. Terminal board fixing nut
11. Terminal bridge
12. Terminal pin
13. Terminal shim
14. Terminal board
15. TB fixing screws
16. TB base
17. Cable gland
18. TB bottomgasket
19. Frame
20. Preload washer
21. Key
22. Rotor
23. Bearing
24. NDE endshield
25. Cooling fan
26. Fan circlip
27. Fan cover
28. Fan cover fixing shim
29. Fan cover fixing screws
30. Endshield fixing nut
31. Rivet
32. Nameplate
33. Foot fixing nut
34. Foot fixing screws
35. Foot

This catalogue is only a reference for users.  
The concrete data be changed please contact with us before ordering.

### Mountings and Positions

Mountings and positions for standard motors, according to IEC 60034-7, are defined by the codes mentioned in the following table.

	Standards			Frame Sizes
	CEI 2-14	IEC 60034-7		56-200
		Code I	Code II	
	B3	IM B3	IM 1001	Standard
	B3/B5	IM B35	IM 2001	Standard
	B5	IM B5	IM 3001	Standard
	B14	IM B14	IM 4001	Standard
	B8	IM B8	IM 1071	Upon request
	B6	IM B6	IM 1051	Upon request
	B7	IM B7	IM 1061	Upon request

	Standards			Frame Sizes
	CEI 2-14	IEC 60034-7		56-200
		Code I	Code II	
	V1	IM V1	IM 3011	Standard
	V3	IM V3	IM 3031	Upon request
	V5	IM V5	IM 1011	Upon request
	V6	IM V6	IM 1031	Upon request
	V1/V5	IM V15	IM 2011	Upon request

### Aluminum Housing Electric Motors Bearings & Oil Seals

Frame	Bearings		Oil Seals	
	Drive End	Non-drive End	Drive End	Non-drive End
63	6201	6201	12×24×5	12×24×5
71	6202	6202	15×25×7	15×25×7
80	6204	6204	20×34×7	20×34×7
90S	6205	6205(6204)※※	25×37×7	25×37×7(20×34×7)
90L	6205	6205(6204)※※	25×37×7	25×37×7(20×34×7)
100L	6206	6206	30×44×7	30×44×7
112M	6306	6206(6306)	30×44×7	30×44×7
132S	6308	6208(6308)	40×58×7	40×58×7
132M/L	6308	6208(6308)	40×58×7	40×58×7
160M	6309	6309	45×65×8	45×65×8
160L	6309	6309	45×65×8	45×65×8
180M	6311	6211	55×72×8	55×72×8
180L	6311	6211	55×72×8	55×72×8
200L	6312	6212	60×80×8	60×80×8

※ Other standards are also available on request, the figures in brackets() are for the MC/ML single phase motors

MS2/MS3 Series Dimensional Drawings

IM B3

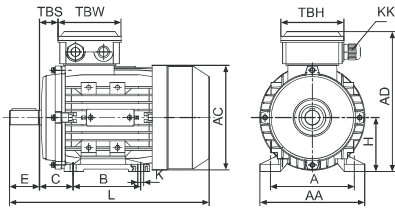

IM B5

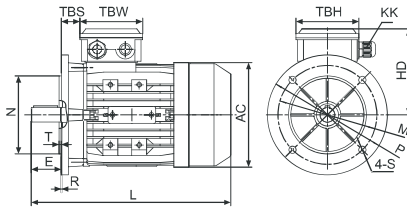

IM B14

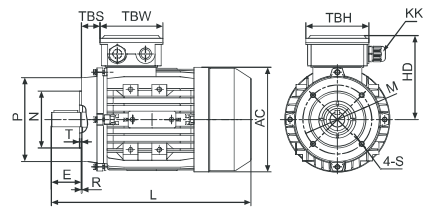

IM B34

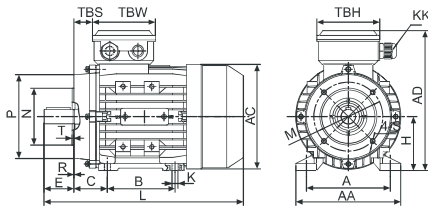

IM B35

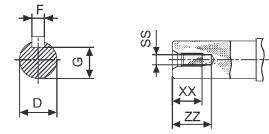
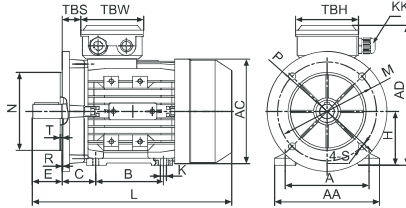

Installation Dimension

Frame	Foot Mounting					Shaft							General										
	H	A	B	C	K	D	E	F	G	SS	XX	ZZ	AA	AD	HD	AC	L	LCCL <sup>°</sup>	KK	TBS	TBW	TBH	
56	56	90	71	36	5.8X8.8	Ø9	20	3	7.2	M3	9	12	110	156	100	Ø117	196	232	1-M16X1.5	14	88	88	
63	63	100	80	40	7X10	Ø11	23	4	8.5	M4	10	14	120	171	108	Ø130	220	258	1-M16X1.5	14	94	94	
71 <sup>°*</sup>	71	112	90	45	7X10	Ø14	30	5	11	M5	12	17	132	186	115	Ø147	241(255)	282(296)	1-M20X1.5	20	94	94	
80	80	125	100	50	10X13	Ø19	40	6	15.5	M6	16	21	160	213	133	Ø163	290	339	1-M20X1.5	27	105	105	
90S	90	140	100	56	10X13	Ø24	50	8	20	M8	19	25	175	229	139	Ø183	312	361	1-M20X1.5	30	105	105	
90L1/L2	90	140	125	56	10X13	Ø24	50	8	20	M8	19	25	175	229	139	Ø183	337/367	386/416	1-M20X1.5	30	105	105	
100 <sup>°*</sup>	100	160	140	63	12X15	Ø28	60	8	24	M10	22	30	198	252	152	Ø205	369(387)	425(443)	2-M20X1.5	26	105	105	
112	112	190	140	70	12X15	Ø28	60	8	24	M10	22	30	220	279	167	Ø229	395	463	2-M25X1.5	32	112	112	
132S	132	216	140	89	12X15	Ø38	80	10	33	M12	28	37	252	318	186	Ø265	437	497	2-M25X1.5	38	112	112	
132M/L	132	216	178	89	12X15	Ø38	80	10	33	M12	28	37	252	318	186	Ø265	475/501	535/561	2-M25X1.5	38	112	112	
160M/L	160	254	210/254	108	15X19	Ø42	110	12	37	M16	36	45	290	384	224	Ø325	640	697	2-M32X1.5	64	143	143	
180M/L	180	279	241/279	121	15X25	Ø48	110	14	42.5	M16	36	45	340	440	260	Ø368	730		2-M32X1.5	73	190	190	
200L	200	318	305	133	19X29	Ø55	110	16	49	M20	42	53	390	460	260	Ø368	745		2-M40X1.5	85	190	190	

Frame	B5						B5R						B14						B14B						
	M	N	P	T	S	R	M	N	P	T	S	R	N	M	P	T	S	R	N	M	P	T	S	R	
56	Ø100	Ø80	Ø120	3.0	Ø7	0							Ø50	Ø65	Ø80	2.5	M5	0							
63	Ø115	Ø95	Ø140	3.0	Ø10	0							Ø60	Ø75	Ø90	2.5	M5	0	Ø80	Ø100	Ø120	3.0	M6	0	
71 <sup>°*</sup>	Ø130	Ø110	Ø160	3.5	Ø10	0	Ø115	Ø95	Ø140	3.5	Ø10	0	Ø70	Ø85	Ø105	2.5	M6	0	Ø95	Ø115	Ø140	3.0	M8	0	
80	Ø165	Ø130	Ø200	3.5	Ø12	0	Ø130	Ø110	Ø160	3.5	Ø10	0	Ø80	Ø100	Ø120	3.0	M6	0	Ø110	Ø130	Ø160	3.5	M8	0	
90S	Ø165	Ø130	Ø200	3.5	Ø12	0	Ø130	Ø110	Ø160	3.5	Ø10	0	Ø95	Ø115	Ø140	3.0	M8	0	Ø110	Ø130	Ø160	3.5	M8	0	
90L1/L2	Ø165	Ø130	Ø200	3.5	Ø12	0	Ø130	Ø110	Ø160	3.5	Ø10	0	Ø95	Ø115	Ø140	3.0	M8	0	Ø110	Ø130	Ø160	3.5	M8	0	
100 <sup>°*</sup>	Ø215	Ø180	Ø250	4.0	Ø15	0	Ø165	Ø130	Ø200	4.0	Ø12	0	Ø110	Ø130	Ø160	3.5	M8	0	Ø130	Ø165	Ø200	3.5	M10	0	
112	Ø215	Ø180	Ø250	4.0	Ø15	0	Ø165	Ø130	Ø200	4.0	Ø12	0	Ø110	Ø130	Ø160	3.5	M8	0	Ø130	Ø165	Ø200	3.5	M10	0	
132S	Ø265	Ø230	Ø300	4.0	Ø15	0	Ø215	Ø180	Ø250	4.0	Ø15	0	Ø130	Ø165	Ø200	4.0	M10	0	Ø180	Ø215	Ø250	4.0	M12	0	
132M/L	Ø265	Ø230	Ø300	4.0	Ø15	0	Ø215	Ø180	Ø250	4.0	Ø15	0	Ø130	Ø165	Ø200	4.0	M10	0	Ø180	Ø215	Ø250	4.0	M12	0	
160M/L	Ø300	Ø250	Ø350	5.0	Ø19	0							Ø180	Ø215	Ø250	4.0	M12	0							
180M/L	Ø300	Ø250	Ø350	5.0	Ø19	0																			
200L	Ø350	Ø300	Ø400	5.0	Ø19	0																			

\*\*\* This frame size has two housing sizes, the rated output is for normal "L" size, and increased output is for the bigger "L" size (refer to the figures in the bracket (" "))



# YE3 SERIES(IE3)

## THREE-PHASE CAST IRON INDUCTION MOTOR

### Operating Conditions:

Ambient temperature:-15°C ≤ ~ ≤ 40°C

Rated voltage:380V or any voltage between 220V - 760V

Rated frequency: 50Hz, 60Hz

Protection class: IP44, IP54, IP55

Insulation class: B, F, H

Altitude: not exceed 1000 m

Cooling method: ICO141

Duty:S1 (continuous)

Connection:Star - connection for up to 3KW , delta-connection for 4KW and above



### YE3 Series IE3 Efficiency Motors Technical Data (400V/50Hz) - 2 pol

Model	Output (kW)	Rated current (A)	Rotation speed (r/min)	Efficiency 100% load(%)	Efficiency 75% load(%)	Efficiency 50% load(%)	Power factor(Φ)	Rated torque(N.m)	Tst / Tn (Times)	Tmin/ Tn (Times)	Tmax/ Tn (Times)	Ist/ In (Times)	Nosie (dB)	Net weight (kg)	Moment of inertia(kg*m <sup>2</sup> )
YE3 801-2	0.75	1.68	2880	80.7	81.0	76.2	0.80	2.49	2.5	2.1	2.8	7.5	67	15.20	0.00093
YE3 802-2	1.1	2.40	2880	82.7	83.5	81.6	0.80	3.65	2.5	1.8	2.8	8	67	17.10	0.00128
YE3 90S-2	1.5	3.06	2880	84.2	84.9	84.0	0.84	4.97	2.5	1.8	2.8	8.5	72	21.5	0.00224
YE3 90L-2	2.2	4.45	2880	85.9	86.4	84.7	0.83	7.30	2.5	1.8	2.8	8.6	72	24.6	0.00279
YE3 100L-2	3	5.65	2900	87.1	88.5	86.8	0.88	9.88	2.5	2.0	2.8	9.5	76	35.5	0.00496
YE3 112M-2	4	7.28	2910	88.1	88.5	87.1	0.90	13.13	2.5	2.0	2.8	10.5	77	44.5	0.00744
YE3 132S1-2	5.5	10.11	2910	89.2	90.2	88.6	0.88	18.05	2.5	2.0	3.0	10	80	63.2	0.01468
YE3 132S2-2	7.5	13.50	2920	90.1	90.8	89.3	0.89	24.53	2.5	1.5	3.0	10	80	70.2	0.01903
YE3 132M1-2	9.2	16.47	2920	90.6	91.2	89.5	0.89	30.09	2.5	1.5	3.0	10	80	76.8	0.02048
YE3 160M1-2	11	19.34	2930	91.2	93.8	93.0	0.90	35.85	2.5	1.4	3.0	9.5	86	118.0	0.05178
YE3 160M2-2	15	26.18	2940	91.9	93.1	92.9	0.90	48.72	2.5	1.4	3.0	10	86	128.0	0.06206
YE3 160L-2	18.5	31.76	2940	92.4	93.5	93.3	0.91	60.09	2.5	1.4	3.0	9.5	86	144.00	0.07669
YE3 180M-2	22	38.5	2945	92.7	94.1	93.6	0.89	71.34	2.5	1.4	3.0	9	89	183.40	0.09665
YE3 200L1-2	30	52.1	2945	93.3	93.8	93.2	0.89	97.3	2.5	1.5	2.5	8.5	92	247.00	0.17351
YE3 200L2-2	37	64.0	2945	93.7	94.4	94.2	0.89	120.0	2.5	1.5	2.5	8.5	92	268.00	0.20008
YE3 225M-2	45	75.9	2950	94	94.6	94.1	0.91	145.7	2.5	1.4	2.5	8.5	92	369.00	0.34366
YE3 250M-2	55	93.5	2960	94.3	94.5	93.1	0.90	177.4	2.5	1.4	2.6	10	93	428.00	0.44434
YE3 280S-2	75	125.6	2960	94.7	94.9	93.7	0.91	242.0	2.5	1.8	2.6	10	94	587.30	0.82911
YE3 280M-2	90	150.3	2960	95	95.2	94.3	0.91	290.4	2.5	1.8	2.6	10	94	655.00	0.98168
YE3 315S-2	110	185.3	2960	95.2	95.5	94.6	0.90	354.9	2.0	1.4	2.3	7	96	980.00	1.70352
YE3 315M-2	132	221.9	2960	95.4	95.5	94.7	0.90	425.9	2.0	1.4	2.3	7	96	1100.00	1.93860
YE3 315L1-2	160	267.8	2960	95.8	95.8	94.5	0.90	516.2	2.0	1.4	2.3	7	99	1155.00	2.19758
YE3 315L2-2	200	334.8	2960	95.8	96.0	94.7	0.90	645.3	2.0	1.4	2.3	7	99	1260.00	2.55368
YE3 355M1-2	220	394.6	2960	95.8	96.2	94.8	0.84	709.8	2.0	1.5	2.3	6.5	103	1590.00	2.95585
YE3 355M2-2	250	448.4	2960	95.8	96.2	94.8	0.84	806.6	2.0	1.5	2.3	6.5	103	1650.00	3.14272
YE3 355L1-2	280	502.2	2960	95.8	96.2	94.8	0.84	903.4	2.0	1.5	2.3	6.5	103	1715.00	3.47911
YE3 355L2-2	315	558.3	2960	95.8	96.2	94.8	0.85	1016.3	2.0	1.5	2.3	6.5	103	1780.00	3.85287

YE3 Series IE3 Efficiency Motors Technical Data (400V/50Hz) - 4 pol

Model	Output (kW)	Rated current (A)	Rotation speed (r/min)	Efficiency 100% load(%)	Efficiency 75% load(%)	Efficiency 50% load(%)	Power factor(Φ)	Rated torque(N.m)	Tst / Tn (Times)	Tmin/ Tn (Times)	Tmax/ Tn (Times)	Ist/In (Times)	Nosie (dB)	Net weight (kg)	Moment of inertia(kg*m <sup>2</sup> )
YE3 802-4	0.75	1.90	1420	82.5	82.8	80.6	0.69	5.04	2.8	2.2	2.8	6.3	58	18.20	0.00155
YE3 90S-4	1.1	2.62	1430	84.1	84.6	83.2	0.72	7.35	2.8	2.2	2.8	6.8	61	23.00	0.00372
YE3 90L-4	1.5	3.63	1430	85.3	86.1	85.2	0.70	10.02	2.8	2.2	3.0	7.3	61	26.30	0.00469
YE3 100L1-4	2.2	4.52	1430	86.7	87.8	85.2	0.81	14.69	2.8	2.2	3.0	8	64	35.50	0.00922
YE3 100L2-4	3	6.33	1435	87.7	88.0	85.9	0.78	19.97	2.5	2.2	3.0	8.2	64	38.50	0.01195
YE3 112M-4	4	7.95	1440	88.6	88.9	87.5	0.82	26.53	2.5	2.2	3.0	8.6	65	47.00	0.01545
YE3 132S-4	5.5	10.67	1440	89.6	90.9	88.9	0.83	36.48	2.5	1.8	3.0	9	71	68.30	0.03397
YE3 132M-4	7.5	14.09	1440	90.4	91.3	91.2	0.85	49.74	2.5	1.6	3.0	9	71	79.00	0.04412
YE3 132M2-4	9.2	17.19	1440	90.9	91.8	90.5	0.85	61.01	2.5	1.6	3.0	9	71	87.50	0.04700
YE3 160M-4	11	20.68	1450	91.4	92.2	91.7	0.84	72.45	2.5	1.3	3.0	10	75	127.00	0.10355
YE3 160L-4	15	27.33	1450	92.1	92.9	92.2	0.86	98.8	2.5	1.3	2.8	8.5	75	160.00	0.13750
YE3 180M-4	18.5	33.5	1460	92.6	93.6	93.0	0.86	121.0	2.5	1.8	3.0	9	76	169.40	0.15530
YE3 180L-4	22	39.2	1460	93	93.7	92.9	0.87	143.9	2.5	1.8	3.0	10	76	196.00	0.19433
YE3 200L-4	30	57.1	1470	93.6	93.7	93.2	0.81	194.9	2.5	1.8	2.8	9	79	252.00	0.29441
YE3 225S-4	37	65.4	1470	93.9	95.2	94.3	0.87	240.4	2.5	1.4	2.5	9.2	81	324.50	0.57838
YE3 225M-4	45	79.3	1470	94.2	95.2	94.5	0.87	292.3	2.5	1.5	2.5	9	81	352.90	0.65309
YE3 250M-4	55	95.4	1470	94.6	95.2	94.5	0.88	357.3	2.5	1.8	2.5	8.5	83	427.40	0.76504
YE3 280S-4	75	131.0	1480	95	95.1	94.8	0.87	484.0	2.5	1.8	2.8	10	86	673.30	1.99603
YE3 280M-4	90	160.5	1480	95.2	95.1	95.0	0.85	580.7	2.5	1.8	2.8	10	86	692.00	2.18345
YE3 315S-4	110	189.1	1480	95.4	95.7	94.6	0.88	709.8	2.2	1.5	2.6	9	93	1027.00	3.71808
YE3 315M-4	132	226.5	1480	95.6	95.8	95.0	0.88	851.8	2.2	1.5	2.6	9	93	1155.00	4.29667
YE3 315L1-4	160	273.9	1480	95.8	96.0	95.1	0.88	1032.4	2.2	1.5	2.6	9	97	1240.00	5.10990
YE3 315L2-4	200	337.9	1480	96	96.2	95.3	0.89	1290.5	2.2	1.5	2.6	9	97	1400.00	6.17334
YE3 355M1-4	220	371.7	1480	96	96.2	95.3	0.89	1419.6	2.0	1.3	2.3	8	101	1560.00	7.04227
YE3 355M2-4	250	422.3	1480	96	96.3	95.4	0.89	1613.2	2.0	1.3	2.3	8	101	1600.00	7.63820
YE3 355L1-4	280	473.0	1480	96	96.4	95.4	0.89	1806.8	2.0	1.3	2.3	8	101	1650.00	8.31927
YE3 355L2-4	315	532.1	1480	96	96.3	95.5	0.89	2032.6	2.0	1.3	2.3	8	101	1700.00	9.34080

YE3 Series IE3 Efficiency Motors Technical Data (400V/50Hz) - 6 pol

Model	Output (kW)	Rated current (A)	Rotation speed (r/min)	Efficiency 100% load(%)	Efficiency 75% load(%)	Efficiency 50% load(%)	Power factor(Φ)	Rated torque(N.m)	Tst / Tn (Times)	Tmin/ Tn (Times)	Tmax/ Tn (Times)	Ist/In (Times)	Nosie (dB)	Net weight (kg)	Moment of inertia(kg*m <sup>2</sup> )
YE3 90S-6	0.75	2.05	935	78.9	79.6	77.2	0.67	7.66	2.0	1.8	2.2	5	57	21.50	0.00435
YE3 90L-6	1.1	2.97	940	81	81.5	80.2	0.66	11.18	2.3	1.8	2.2	5.2	57	25.50	0.00611
YE3 100L-6	1.5	3.55	940	82.5	83.0	81.6	0.74	15.24	2.0	1.7	2.2	5.2	61	33.50	0.00972
YE3 112M-6	2.2	5.38	940	84.3	85.0	83.2	0.70	22.35	2.0	1.8	2.2	6.2	65	40.00	0.01637
YE3 132S-6	3	6.84	940	85.6	86.1	84.5	0.74	30.48	2.0	1.7	2.2	6	69	59.00	0.03223
YE3 132M1-6	4	8.99	950	86.8	87.6	85.2	0.74	40.21	2.0	1.6	2.5	7	69	75.50	0.04338
YE3 132M2-6	5.5	12.71	950	88	88.8	86.9	0.71	55.29	2.3	1.8	2.5	7.5	69	76.30	0.05443
YE3 160M-6	7.5	16.2	960	89.1	90.3	88.0	0.75	74.6	2.3	1.4	2.8	7.5	73	112.00	0.08726
YE3 160L-6	11	23.1	960	90.3	91.2	88.5	0.76	109.4	2.5	1.4	2.8	8.5	73	134.00	0.13544
YE3 180L-6	15	30.1	960	91.2	92.0	90.3	0.79	149.2	2.5	1.4	2.8	8	73	184.50	0.27973
YE3 200L1-6	18.5	36.4	970	91.7	92.3	90.6	0.80	182.1	2.5	1.4	2.8	9.5	76	231.00	0.38345
YE3 200L2-6	22	42.5	970	92.2	93.0	91.3	0.81	216.6	2.5	1.5	2.8	10	76	249.00	0.44941
YE3 225M-6	30	53.0	975	92.9	93.8	90.9	0.88	293.8	1.8	1.5	2.2	7	76	339.00	0.67058

YE3 Series IE3 Efficiency Motors Technical Data (400V/50Hz) - 6 pol

Model	Output (kW)	Rated current (A)	Rotation speed (r/min)	Efficiency 100% load(%)	Efficiency 75% load(%)	Efficiency 50% load(%)	Power factor(Φ)	Rated torque(N.m)	Tst/Tn (Times)	Tmin/Tn (Times)	Tmax/Tn (Times)	Ist/In (Times)	Nosie (dB)	Net weight (kg)	Moment of inertia(kg*m <sup>2</sup> )
YE3 250M-6	37	67.3	975	93.3	94.0	91.8	0.85	362.4	1.8	1.3	2.0	7	78	399.40	0.99243
YE3 280S-6	45	83.5	980	93.7	94.6	92.7	0.83	438.5	2.5	1.8	2.8	10	80	551.00	2.20274
YE3 280M1-6	55	99.3	980	94.1	95.0	93.4	0.85	536.0	2.5	1.8	2.8	10	80	624.30	2.57302
YE3 315S-6	75	139.6	980	94.6	94.8	93.2	0.82	730.9	2.0	1.3	2.3	7.5	85	860.00	3.80317
YE3 315M-6	90	166.9	980	94.9	95	93.4	0.82	877.0	2.0	1.3	2.3	7.5	85	970.00	4.45274
YE3 315L1-6	110	203.6	980	95.1	95.4	94	0.82	1071.9	2.0	1.3	2.3	7.5	85	1070.00	5.53956
YE3 315L2-6	132	243.6	980	95.4	95.7	94.2	0.82	1286.3	2.0	1.3	2.3	7.5	85	1196.00	6.62638
YE3 355M1-6	160	294.6	980	95.6	95.8	94.3	0.82	1559.2	2.0	1.3	2.3	7.5	92	1537.00	8.97637
YE3 355M2-6	200	367.5	980	95.8	95.8	94.3	0.82	1949.0	2.0	1.3	2.3	7.5	92	1720.00	11.00175
YE3 355L1-6	220	404.2	980	95.8	96	94.2	0.82	2143.9	2.0	1.3	2.3	7.5	92	1800.00	11.64134
YE3 355L-6	250	459.3	980	95.8	96	94.3	0.82	2436.2	2.0	1.3	2.3	7.5	92	1880.00	13.56011



IM B3

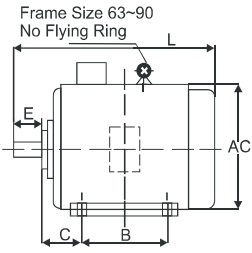

Frame Size 63~132

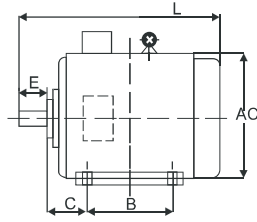

Frame Size 160~355

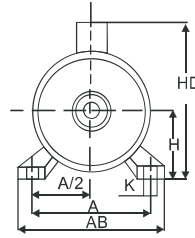
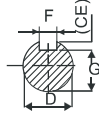

Frame Size 63~71

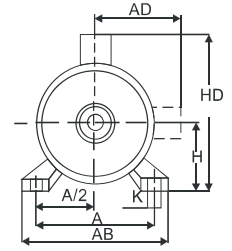

Frame Size 80~355

Installation Dimension

Frame No.	Poles	Mounting Dimensions & Tolerance											Frame Dimensions																			
		A	A/2	B	C	D	E	F	G <sup>1)</sup>	H	K <sup>2)</sup>	AB	AC	AD	HD	L																
80	2,4,6,8	125	62.5	100	50	±1.5	19	40	6	15.5	0 -0.10	80	10	+0.036 0	165	175	145	220	295													
90S		140	70	100	56		24								50	±0.31	20	90	205	215	180	270	320									
90L				125	63		28								60	±0.37	24	112	230	240	190	300	345									
100L		160	80	140	63	±2.0	38	80	10	0 -0.036	24	100	0 -0.5	12	205	215	180	270	385													
112M		190	95	140	70										42	80	±0.43	37	160	230	240	190	300	400								
132S				178	89										48	110	±0.43	42.5	180	355	380	280	455	700								
132M		216	108	140	89	±3.0	55	140	18	0 -0.043	53	100	0 -1.0	15	270	275	210	345	510													
160M		254	127	210	108										42	110	±0.43	37	160	320	330	255	420	615								
160L				254	121										48	110	±0.43	42.5	180	355	380	280	455	700								
180M		279	139.5	241	121	±4.0	60	140	18	0 -0.20	58	250	0 -1.0	19	395	420	305	505	770													
180L		318	159	279	133										55	140	±0.50	18	0 -0.043	53	225	24	+0.430 0	435	470	335	560	815				
200L				318	159										305	133	60	140	±0.43	16	49			225	490	510	370	615	910			
225S	4,8	356	178	286	149	±4.0	65	140	18	0 -0.052	67.5	280	24	+0.520 0	635	645	530	845	815													
225M	2			311															190	65	140	±0.50	18	0 -0.043	58	225	550	580	410	680	1035	
250M	4,6,8			311															190	75	140	±0.50	18	0 -0.052	67.5	225	550	580	410	680	1035	
250M	2	406	203	349	168	±4.0	65	140	18	0 -0.052	67.5	280	24	+0.520 0	635	645	530	845	845													
280S	4,6,8			368															190	65	140	±0.50	18	0 -0.043	58	225	550	580	410	680	1035	
280M	4,6,8	368	190	75	140														±0.50	18	0 -0.052	67.5	225	550	580	410	680	1035				
315S	2	508	254	406	216	±4.0	65	140	18	0 -0.043	58	315	28	+0.520 0	635	645	530	845	1185													
315S	4,6,8,10			406															216	65	140	±0.50	18	0 -0.052	71	315	635	645	530	845	1215	
315M	2			457															228.5	419	190	±4.0	65	140	18	0 -0.043	58	315	28	635	645	530
315L	4,6,8,10	457	228.5	419	190	±4.0	65	140	18	0 -0.052	71	315	28	635	645	530	845	1325														
315L	2	610	305	630	254	±4.0	65	140	18	0 -0.043	58	355	28	+0.520 0	635	645	530	845	1295													
355M	4,6,8,10																		630	254	65	140	±0.50	18	0 -0.052	71	315	635	645	530	845	1325
355L	2																		610	305	630	254	±4.0	65	140	18	0 -0.043	58	315	28	635	645
355L	4,6,8,10	610	305	630	254	±4.0	65	140	18	0 -0.052	71	315	28	635	645	530	845	1325														
355M	2	610	305	630	254	±4.0	75	140	20	0 -0.052	67.5	355	28	+0.520 0	635	645	530	845	1500													
355M	4,6,8,10																		630	254	75	140	±0.50	20	0 -0.052	86	355	635	645	530	845	1530
355L	2																		610	305	630	254	±4.0	75	140	20	0 -0.052	67.5	355	28	635	645
355L	4,6,8,10	610	305	630	254	±4.0	75	140	20	0 -0.052	67.5	355	28	635	645	530	845	1530														





# MC SERIES

## SINGLE-PHASE CAPACITOR-START ASYNCHRONOUS INDUCTION MOTOR WITH ALUMINIUM HOUSING

MC series aluminum housing single-phase capacitor-start asynchronous motors, with latest design in entirety, are made of selected quality materials and conform to the IEC standard.

MC motors have good performance, safety and reliable operation, nice appearance, and can be maintained very conveniently, while with low noise, little vibration and at the same time of light weight and simple construction.

High starting torque, perfect starting performance, generally the multiple of the starting torque and suitable for the occasion where big starting torque and small starting current, such as air-compressors, pumps, refrigerators, medical apparatus, and many other machines needing full-load start.

### Operating Conditions:

Ambient temperature:	-15 °C <math>\theta</math> <math>\leq 40</math> °C
Altitude:	Not exceeding 1000meters
Rated voltage:	220V
Rated frequency:	50Hz / 60Hz
Duty/Rating:	Continuous (S1)
Insulation class:	Class B / F
Protection class:	IP54, IP55
Cooling method:	IC0141

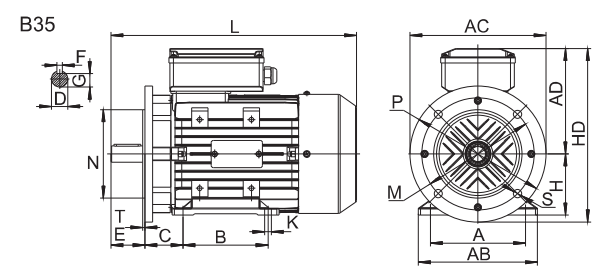
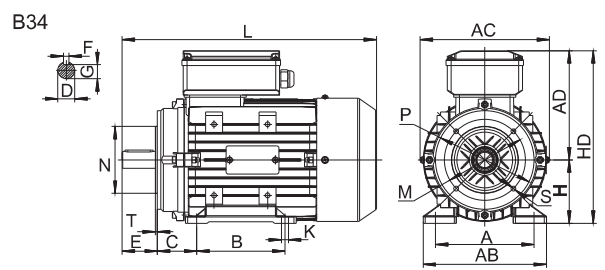
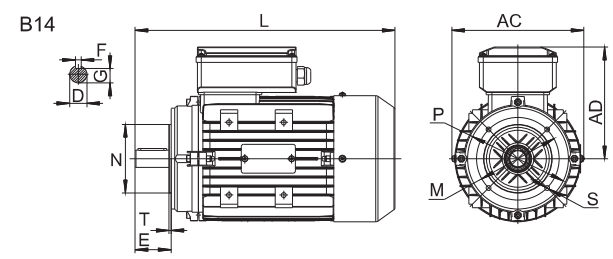
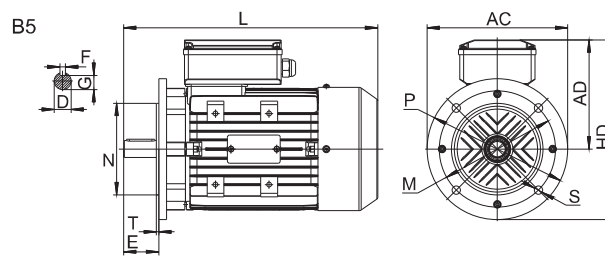
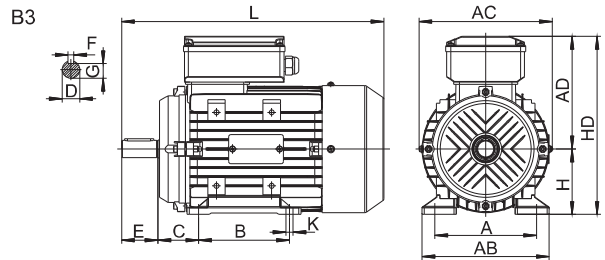

**Installation Dimension**

in mm

Frame No	Installation Size										Installation Size For B14						Installation Size For B5						Overall Dimension				
	A	B	C	D	E	F	G	H	K		M	N	P	R	S	T	M	N	P	R	S	T	AB	AC	AD	HD	L
71	112	90	45	14	30	5	11	71	7		85	70	105	0	M6	2.5	130	110	160	0	10	3.5	145	145	125	205	255
80	125	100	50	19	40	6	15.5	80	10		100	80	120	0	M6	3.0	165	130	200	0	12	3.5	160	165	135	235	295
90S	140	100	56	24	50	8	20	90	10		115	95	140	0	M8	3.0	165	130	200	0	12	3.5	180	185	145	265	335
90L	140	125	56	24	50	8	20	90	10		115	95	140	0	M8	3.0	165	130	200	0	12	3.5	180	185	145	265	360
100L	160	140	63	28	60	8	24	100	12		-	-	-	0	-	-	215	180	250	0	15	4.0	205	215	170	280	380
112M	190	140	70	28	60	8	24	112	12		-	-	-	0	-	-	215	180	250	0	15	4.0	245	240	180	310	400

**TECHNICAL DATA**

TYPE	Power		Voltage (V)	Current (A)	Speed (r/min)	Eff (%)	Power Factor	Tstart/Tn (Time)	Tmax/Tn (Time)	Starting A. (A)
	KW	HP								
<b>220V 50Hz Synchronous Speed 3000 r/min (2 Poles)</b>										
MC711-2	0.18	0.25	220	2	2800	60	0.72	3.0	1.8	12
MC712-2	0.25	0.33	220	2.5	2800	64	0.74	3.0	1.8	15
MC801-2	0.37	0.5	220	3.5	2800	65	0.77	2.8	1.8	21
MC802-2	0.55	0.75	220	4.8	2800	68	0.79	2.8	1.8	29
MC90S-2	0.75	1	220	6	2800	70	0.80	2.5	1.8	37
MC90L-2	1.10	1.5	220	9	2800	72	0.80	2.5	1.8	60
MC100L1-2	1.50	2	220	11.5	2900	74	0.81	2.5	1.8	80
MC100L2-2	2.20	3	220	16.6	2900	75	0.81	2.2	1.8	120
MC112M-2	3.00	4	220	21.6	1400	76	0.82	2.2	1.8	150
<b>220V 50Hz Synchronous Speed 1500 r/min (4 Poles)</b>										
MC711-4	0.12	0.18	220	2	1400	50	0.58	3.0	1.8	90
MC712-4	0.18	0.25	220	2.6	1400	53	0.62	2.8	1.8	12
MC801-4	0.25	0.33	220	3.2	1400	58	0.63	2.8	1.8	15
MC802-4	0.37	0.5	220	4.3	1400	62	0.64	2.5	1.8	21
MC90S-4	0.55	0.75	220	5.6	1400	66	0.69	2.5	1.8	29
MC90L-4	0.75	1	220	6.9	1400	68	0.73	2.5	1.8	37
MC100L1-4	1.10	1.5	220	9.9	1400	71	0.74	2.5	1.8	60
MC100L2-4	1.50	2	220	12.5	1450	73	0.75	2.5	1.8	80
MC112M-4	2.20	3	220	17.7	1450	74	0.76	2.2	1.8	120



# ML SERIES

## ALUMINIUM HOUSING SINGLE PHASE CAPACITOR START AND CAPACITOR RUN ASYNCHRONOUS MOTOR

Conform to the IEC standard. Be made of selected quality materials, latest design in entirety. Good performance, low noise, little vibration, and safety and reliable operation. Nice appearance, light weight. Be maintained very conveniently, simple construction. Good general performance, 1.8 to 2.5 times more than the rated torque.

### Operating Conditions:

Ambient temperature:  $-15^{\circ}\text{C} \leq \theta \leq 40^{\circ}\text{C}$

Altitude: not exceed 1000m



IM B3

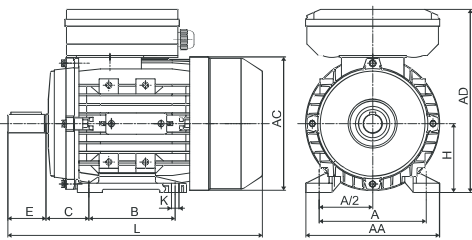

IM B5

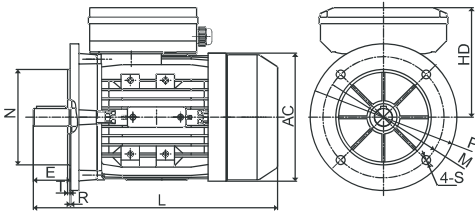

IM B14

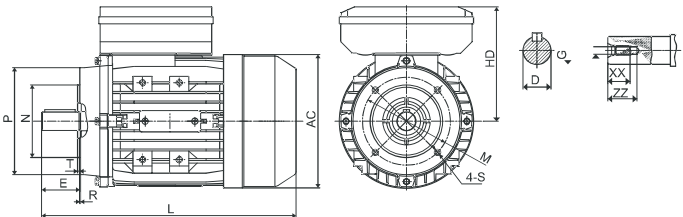

### Installation Dimension

Frame Size	Mounting Dimensions																Overall Dimensions					Shaft End Screw Dimensions							
	A	B	C	D	E	F	G	H	K	IM B14						IM B5						AA	AC	AD	HD	L	SS	XX	ZZ
										M	N	P	R	S	T	M	N	P	R	S	T								
63	100	80	40	11	23	4	8.5	63	7X10	75	60	90	0	M5	2.5	115	95	140	0	φ10	3.0	120	130	179	116	212	M4	10	15
71	112	90	45	14	30	5	11	71	7X10	85	70	105	0	M6	2.5	130	110	160	0	φ10	3.5	132	145	194	123	255	M5	12	18
80	125	100	50	19	40	6	15.5	80	10X13	100	80	120	0	M6	3.0	165	130	200	0	φ12	3.5	157	165	223	143	290	M6	16	22
90S	140	100	56	24	50	8	20	90	10X13	115	95	140	0	M8	3.0	165	130	200	0	φ12	3.5	172	185	240	150	335	M8	20	25
90L	140	125	56	24	50	8	20	90	10X13	115	95	140	0	M8	3.0	165	130	200	0	φ12	3.5	172	185	240	150	365	M8	20	25
100L	160	140	63	28	60	8	24	100	12X15	130	110	160	0	M8	3.5	215	180	250	0	φ15	4.0	196	205	260	160	398/416	M10	22	28
112M	190	140	70	28	60	8	24	112	12X15	130	110	160	0	M8	3.5	215	180	250	0	φ15	4.0	222	230	295	183	416	M10	22	28

**TECHNICAL DATA (at 230V/50Hz)**

Model	Power (KW)	Current (A)	Speed (r/min)	Eff. (%)	Power Factor (CosΦ)	Rate Torque (N.M)	Tst/Tn (Times)	Tmax/Tn (Times)	Starting Current (A)	Run Capacitor (μF/V)	Start Capacitor (μF/V)	Noise dB (A)	W.T (Kg)
ML631-2	0.18	1.38	2710	63	0.9	0.63	2.5	1.6	8	10μF/450V	50μF/250V	70	3.9
ML632-2	0.25	1.89	2710	64	0.9	0.88	2.5	1.6	10	10μF/450V	100μF/250V	73	4.4
ML711-2	0.37	2.66	2780	65	0.93	1.27	2.5	1.8	15	12μF/450V	100μF/250V	75	6.1
ML712-2	0.55	3.78	2790	68	0.93	1.88	2.5	1.8	20	16μF/450V	100μF/250V	76	7
ML801-2	0.75	4.87	2800	72	0.93	2.56	2.5	1.8	30	30μF/450V	150μF/250V	76	9
ML802-2	1.1	7.04	2810	73	0.93	3.74	2.5	1.8	40	35μF/450V	150μF/250V	79	10.3
ML90S-2	1.5	9.48	2810	74	0.93	5.10	2.5	1.8	55	40μF/450V	200μF/300V	84	16.3
ML90L-2	2.2	13.57	2810	75	0.94	7.48	2.5	1.8	75	50μF/450V	250μF/300V	84	16.7
ML100L-2	3.0	17.83	2830	77	0.95	10.13	2.5	1.7	110	50μF/450V	400μF/300V	88	25
ML112M1-2	3.7	21.48	2850	78	0.96	12.40	2.5	1.7	140	60μF/450V	400μF/300V	90	33
ML112M2-2	4.0	22.18	2850	80	0.98	13.41	2.5	1.7	150	60μF/450V	400μF/300V	90	34.2
ML631-4	0.12	1.05	1350	55	0.9	0.85	2.5	1.6	6	10μF/450V	30μF/250V	64	4.1
ML632-4	0.18	1.55	1350	56	0.9	1.27	2.5	1.6	8.5	12μF/450V	40μF/250V	64	4.5
ML711-4	0.25	2.01	1380	60	0.9	1.73	2.5	1.7	10	16μF/450V	75μF/250V	66	5.9
ML712-4	0.37	2.84	1380	63	0.9	2.56	2.5	1.7	15	16μF/450V	75μF/250V	68	6.9
ML801-4	0.55	4.03	1400	66	0.9	3.75	2.5	1.8	20	20μF/450V	100μF/250V	71	9.6
ML802-4	0.75	5.25	1410	69	0.9	5.08	2.5	1.8	30	25μF/450V	100μF/250V	71	10.9
ML90S-4	1.1	7.24	1410	71	0.93	7.45	2.5	1.8	40	60μF/450V	250μF/250V	74	13.8
ML90L-4	1.5	9.61	1400	73	0.93	10.24	2.5	1.8	55	70μF/450V	300μF/300V	79	16.7
ML100L1-4	2.2	13.90	1430	74	0.93	14.70	2.5	1.8	75	70μF/450V	300μF/300V	79	22.8
ML100L2-4	3	18.70	1440	75	0.93	19.91	2.5	1.8	110	80μF/450V	400μF/300V	83	28.7
ML112M1-4	3.7	21.99	1440	77	0.95	24.55	2.5	1.7	140	80μF/450V	400μF/300V	86	31
ML112M2-4	4.0	22.41	1440	80	0.97	26.54	2.5	1.7	150	80μF/450V	400μF/300V	86	32.8



# MYT SERIES

## ALUMINIUM HOUSING SINGLE PHASE CAPACITOR RUN ASYNCHRONOUS MOTOR

MYT series Aluminum housing single-phase capacitor-run asynchronous motors, with the international latest design, are made of quality materials and meet the relative standards of IEC. MYT series motors have following features: good performance, safe and reliable operation, nice appearance, convenient maintenance, low noise, slight vibration, light weight and simple construction.

This series motors can be used on household appliance, pumps, fans and recording meters, etc.

### Operating Conditions:

Ambient temperature:  $-15^{\circ}\text{C} \leq \sim \leq 40^{\circ}\text{C}$

Altitude: not exceed 1000m

Rated voltage:  $\pm 5\%$



IM B3

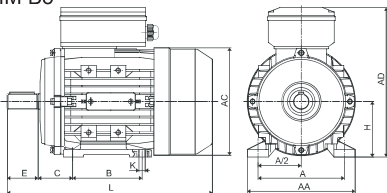

IM B5

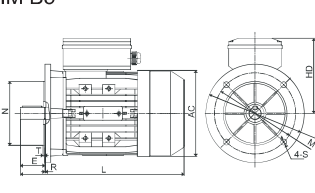

IM B14

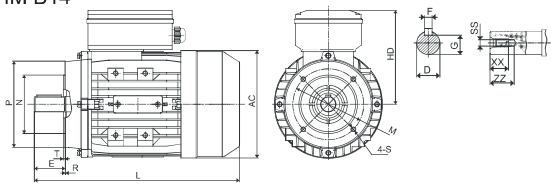

### Installation Dimension

Frame Size	Mounting Dimensions																			Overall Dimensions					Shaft End Screw Dimensions				
	A	B	C	D	E	F	G	H	K	IM B14					IM B5														
	M	N	P	T	R	S	M	N	P	T	R	S	AA	AC	AD	HD	L	SS	XX	ZZ									
56	90	71	36	φ9	20	3	7.2	56	5.8x8.8	φ65	φ50	φ80	2.5	0	M5	φ100	φ80	φ120	3.0	0	φ7	110	φ117	144	88	196	M3	9	12
63	100	80	40	φ11	23	4	8.5	63	7x10	φ75	φ60	φ90	2.5	0	M5	φ115	φ95	φ140	3.0	0	φ10	120	φ130	181	118	220	M4	10	14
71*	112	90	45	φ14	30	5	11	71	7x10	φ85	φ70	φ105	2.5	0	M6	φ130	φ110	φ160	3.5	0	φ10	132	φ147	196	125	241/255	M5	12	17
80	125	100	50	φ19	40	6	15.5	80	10x13	φ100	φ80	φ120	3.0	0	M6	φ165	φ130	φ200	3.5	0	φ12	160	φ163	226	146	290	M6	16	21
90S	140	100	56	φ24	50	8	20	90	10x13	φ115	φ95	φ140	3.0	0	M8	φ165	φ130	φ200	3.5	0	φ12	175	φ183	243	153	312	M8	19	25
90L	140	125	56	φ24	50	8	20	90	10x13	φ115	φ95	φ140	3.0	0	M8	φ	φ130	φ200	3.5	0	φ12	175	φ183	243	153	337/367	M8	19	25
100L**	160	140	63	φ28	60	8	24	100	12x15	φ130	φ110	φ160	3.5	0	M8	φ215	φ180	φ250	4.0	0	φ15	198	φ205	265	165	369/387	M10	22	30

**Technical Data (at 50Hz)**

Model	Power (kw)	Current (A)	Speed (r/min)	Eff. (%)	Power Factor (Cos)	Tst/Tn (Times)	Tmax/Tn (Times)	Starting Current (A)	Run Capacitor (μF/V)	Noise dB(A)	W.T (kg)
MYT561-2	0.09	0.83	2740	54	0.91	0.69	1.8	2.5	4μF/450V	67	2.8
MYT562-2	0.12	0.98	2740	60	0.93	0.69	1.8	3.5	6μF/450V	67	3.05
MYT631-2	0.18	1.40	2750	62	0.93	0.7	1.8	4.5	10μF/450V	70	4
MYT632-2	0.25	1.80	2750	65	0.93	0.65	1.75	6	12μF/450V	70	4.7
MYT711-2	0.37	2.60	2640	66	0.94	0.72	1.65	8	16μF/450V	75	6.1
MYT712-2	0.55	3.60	2760	71	0.95	0.7	1.8	14	20μF/450V	75	7.7
MYT801-2	0.75	4.50	2735	73	0.98	0.68	1.75	16	30μF/450V	75	10.25
MYT802-2	1.1	6.60	2720	74	0.98	0.65	1.8	23	40μF/450V	78	11.6
MYT90S-2	1.5	8.50	2755	76	0.98	0.65	1.8	31	50μF/450V	80	14.55
MYT90L-2	2.2	12.30	2765	77	0.98	0.65	1.8	51	70μF/450V	80	17.8
MYT100L-2	3	16.90	2765	77	0.99	0.55	1.75	64	100μF/450V	83	23.7
MYT562-4	0.09	0.90	1370	50	0.92	0.6	1.75	3	8μF/450V	63	3.6
MYT631-4	0.12	1.20	1370	52	0.92	0.6	1.75	3	10μF/450V	65	4.45
MYT632-4	0.18	1.60	1370	54	0.94	0.6	1.6	4	12μF/450V	65	5.05
MYT711-4	0.25	2.00	1320	56	0.94	0.75	1.6	5	16μF/450V	65	6.2
MYT712-4	0.37	2.90	1325	58	0.94	0.7	1.55	7	20μF/450V	68	7.3
MYT801-4	0.55	3.90	1340	64	0.94	0.7	1.7	11	25μF/450V	73	10.05
MYT802-4	0.75	5.30	1340	64	0.94	0.7	1.75	15	35μF/450V	73	11.4
MYT90S-4	1.1	7.00	1355	72	0.95	0.68	1.8	22	60μF/450V	75	14.4
MYT90L-4	1.5	9.30	1360	74	0.95	0.68	1.8	32	70μF/450V	78	17.5
MYT100L 1-4	2.2	12.60	1390	78	0.97	0.48	1.75	49	80μF/450V	80	24.5
MYT100L 2-4	3	16.50	1380	79	0.99	0.45	1.6	61	120μF/450V	80	32
MYT631-6	0.09	0.92	900	46	0.92	0.8	1.45	2	8μF/450V	63	5.1
MYT632-6	0.12	1.05	900	54	0.92	0.75	1.45	3	11μF/450V	63	6
MYT711-6	0.18	1.55	900	55	0.92	0.7	1.5	4	16μF/450V	68	6.3
MYT712-6	0.25	2.07	900	57	0.92	0.68	1.5	5	20μF/450V	68	7.6
MYT801-6	0.37	2.82	900	62	0.92	0.68	1.6	8	25μF/450V	68	9
MYT802-6	0.55	4.08	900	63	0.93	0.68	1.6	14	30μF/450V	70	11.6
MYT90S-6	0.75	5.20	900	66	0.95	0.65	1.6	16	40μF/450V	70	13.5
MYT90L-6	1.1	7.51	900	67	0.95	0.62	1.6	25	50μF/450V	70	16.2

Note: MYT is high starting torque series single phase capacitor–run motors